

Alpha-100 Series

Operating Instructions



1. Product Introduction

This series of grinding and polishing machine is suitable for rough grinding, fine grinding and polishing of metallographic/ petrographic samples and it is widely used for material analysis/ theory analysis laboratories in various enterprises and scientific research institutions.

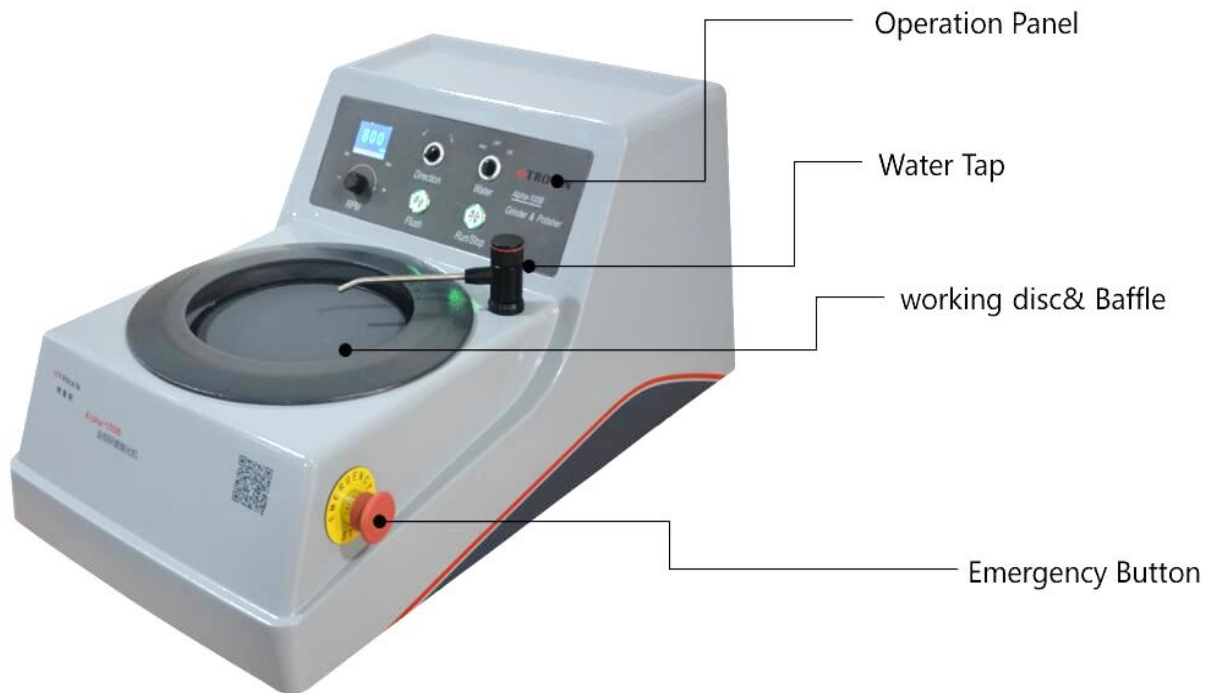

Button Control Panel



Membrane button type
operational Panel

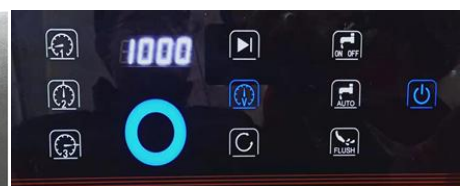

Touch tempered glass
Panel

Features:

1. One-button flushing and cleaning, effective prevent the obstruction causing by grinding debris.
2. Fully sealed in bowl, never leakage, safe and reliable.
3. Faucet can be switched to automatic mode, less operations for manual grinding and polishing.
4. Large diameter drain hose, not easy to blocking and drainage quickly.
5. Retractable water hose for easy cleaning and remaining.
6. Built-in smart cooling fan to prevent motor getting hot at low speed.
7. Optional glass operation panel, easy to clean and good at sealing.
8. Optional buttons operation panel, simple and practical for using.
9. A recess on the top for placing consumable and samples.

2.Parameters

working disc	Rotational Speed	50-1000rpm
	Diameter	8"-10"(203/254mm)
	Running Direction	Clockwise / Counterclockwise
	Torque@300rpm	3N m
Electric	Voltage/Frequency	110V/60Hz 或 220V/50Hz
	Rated Power	750W
	Standby Power	15W
	Rated Current	2.9A
	Maximum Current@220V	5A
Water Supply	Maximum Pressure	0.6MPa
	Pipe Diameter Of Water purifying End	Φ8mm
	Pipe Diameter Of Flushing End	Φ10mm
	Outer Diameter Of Outlet Pipe	Φ32mm
	Circulating Water Tank (Optional)	30L, minimum filtration accuracy: 0.01um
Operation panel	Button Control Panel	Standard Configuration
	Membrane button type operational Panel	Optional
	Touch tempered glass Panel	Optional
Noise Level	Standby, Measuring At 1 Meter	<45dBA
Use environment	Temperature	-20°C - 60°C
	Humidity	0-95%RH
Dimensions	Long × wide × high (mm)	740×455×340
Weight	KG	39

3.Product Dimensions

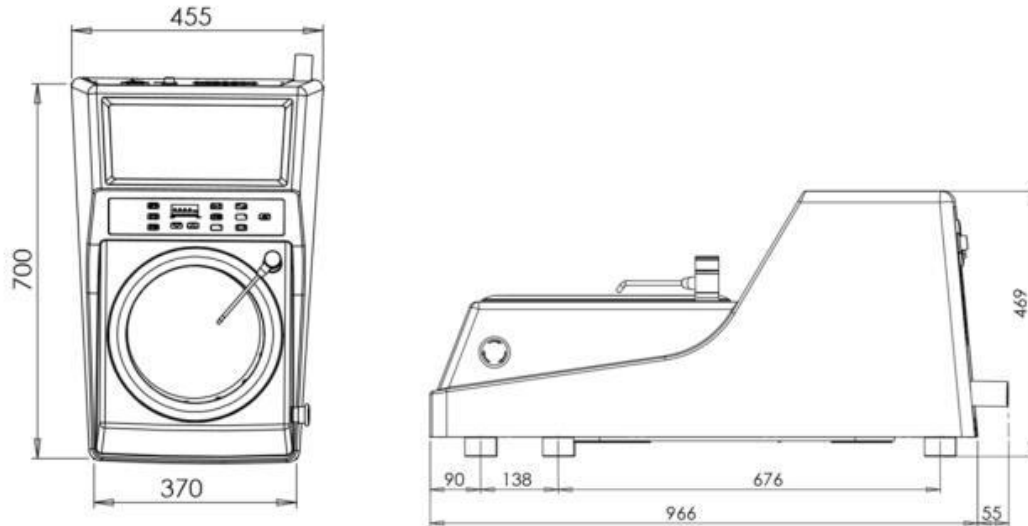

4. Control panel operation (three types of the control panel are available)

4.1. Button Control Panel

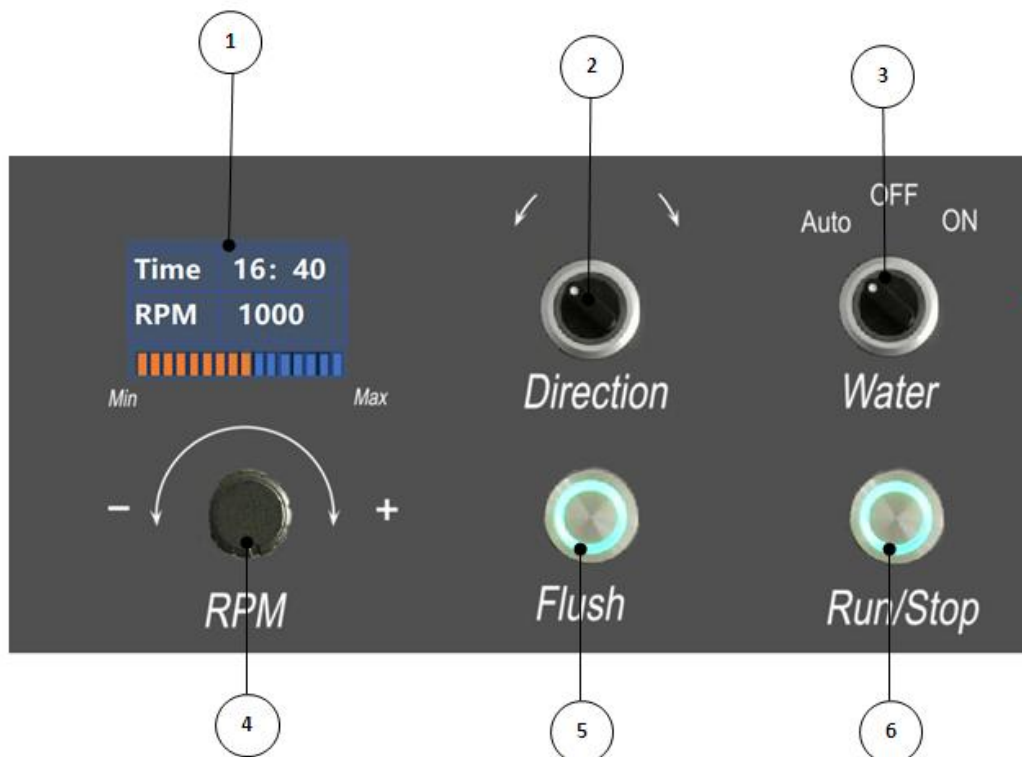

1. LCD. Display the current speed and running time. Speed range: 50-1000RPM. Time range: 0 - 99 minutes;
 2. Adjust the running direction of the working disc.
 3. The working mode of cooling water. There are three ways:
 - ON: Cooling water turns on;
 - OFF: Cooling water closed off;
 - Auto: The working disc rotates and the cooling water turns on automatically. The working disc stops and the cooling water shuts off automatically.
 4. Speed adjusting knob. It is also a knob to adjust the time value when setting Flush time.
 6. Washing button: Press down, the sprinkler in the working disc sprays water according to the set time and then the debris will be washed away. When washing and cooling water is turned on, the button lamp is red.
- Setting of flushing time: double press the Flush button , then the LCD displays the current setting time of Flush and rotate the "speed control button" to change the setting value.
7. Start/ Stop button. When it is running, the button lamp is red.

4.2. Membrane button type operational panel

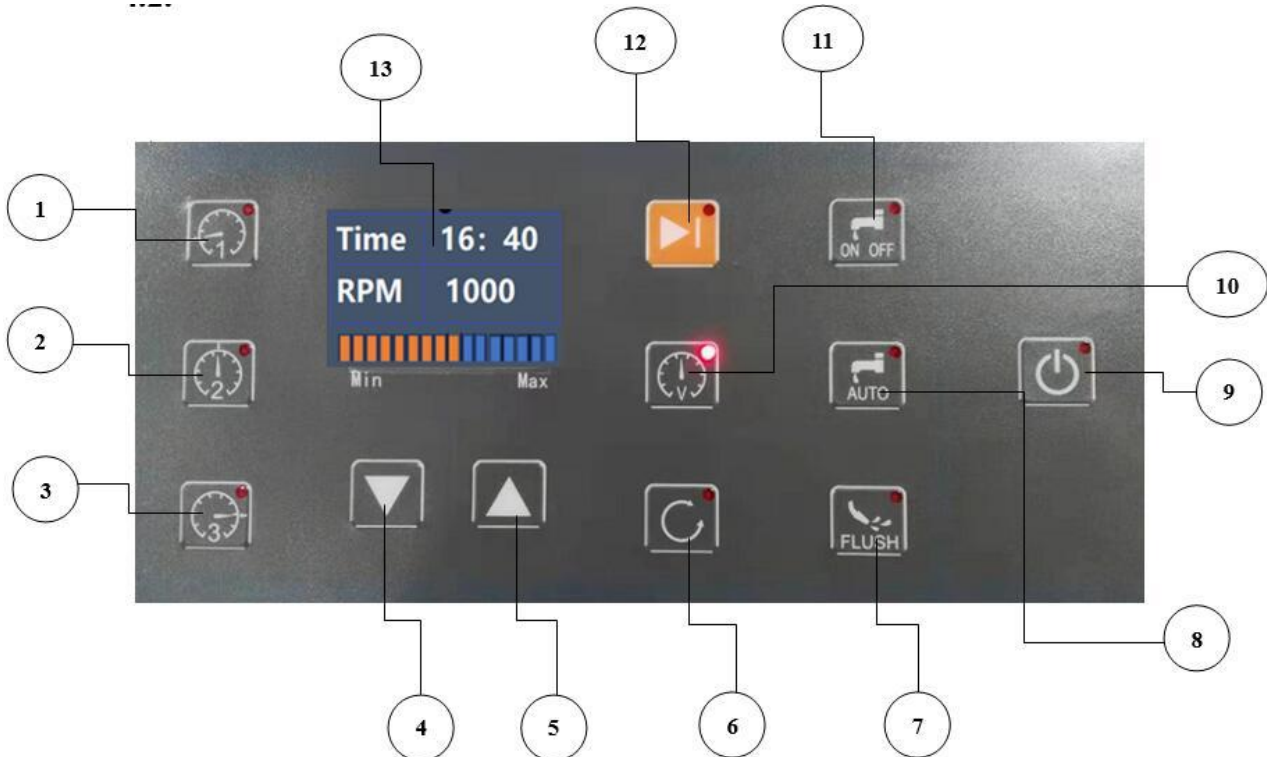

(1)(2)(3) : Three gears preset revolving speed, press the button and running speed will be based on the saved values. In this mode, the revolving speed can not be adjusted.

(4)(5) : “Decrease” and “Increase” keys;

(6) : Revolving Direction Control Button;

(7) : Flushing button. Press down the button, the sprinkler in the working disc sprays water according to the setting time and then the debris will be washed away.

(8) : Automatic switch cooling water mode. In this mode, the grinding plate rotates and the cooling water opens automatically and when the grinding plate stops and the cooling water.

(9) : Panel power button.

(10) : Adjustable revolving speed mode. In this mode, the revolving speed can be changed by pressing the key “Up” and “Down”.

(11) : Manual switch cooling water key.

(12) : Start/stop key.

(13) : LCD Display Screen. Display current revolving speed and running time. Speed range: 50-1000RPM. Time range: 0-99 minutes.

How to change the preset three gears speed and flush washing time?

Press the gear key three times, When "RPM" (Time) flashing on the LCD screen, it indicates that it has entered the parameter setting mode and then the current parameter value can be changed by pressing “Up” and “Down” buttons. After setting, press the gear key again to exit the setting mode and save the parameters.

4.3 Touch tempered glass panel

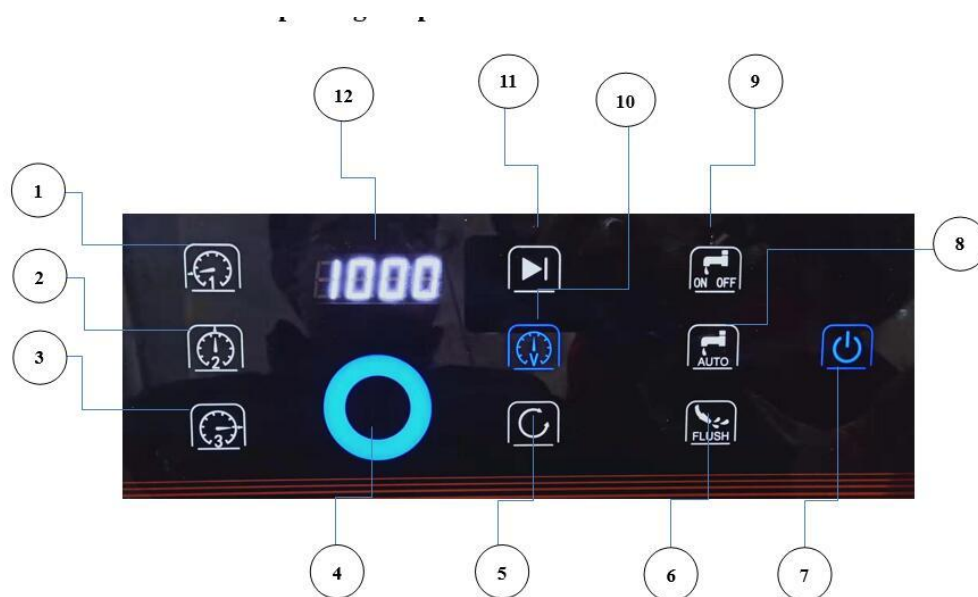

(1)(2)(3) : Three gears preset revolving speed, press the button and running speed will be based on the saved values. In this mode, the revolving speed can not be adjusted.

(4) : Revolving speed adjusting panel. It is used to change the revolving speed value or parameter.

(1)(2)(3) : Three gears preset revolving speed, press the button and running speed will be based on the saved values. In this mode, the revolving speed can not be adjusted.

(4) : Revolving speed adjusting panel. It is used to change the revolving speed value or parameter.

(7) : Panel power button.

(8) : Automatic switch cooling water mode. In this mode, the grinding disc rotates and the cooling water opens automatically and when the grinding disc stops and the cooling water closes automatically.

(9) : Manual switch cooling water key.

(10) : Adjustable revolving speed mode. In this mode the revolving speed can be adjusted by “revolving speed adjusting panel”. Clockwise slide to increase the revolving speed, counterclockwise slide to decrease the revolving speed. The adjusting interval is 50RPM.

(11) : Start/stop key.

(12) : Revolving speed displayed digital panel.

How to change the preset three gears speed and flush washing time?

Press the gear key three times, When the “Revolving Speed Displayed Digital panel” flashing on the LCD screen, it indicates that it has entered the parameter setting mode and then the current parameter value can be changed by sliding the revolving speed adjusting panel. After setting, press the gear key again to exit the setting mode and save the parameters.

2. Back panel operation instruction

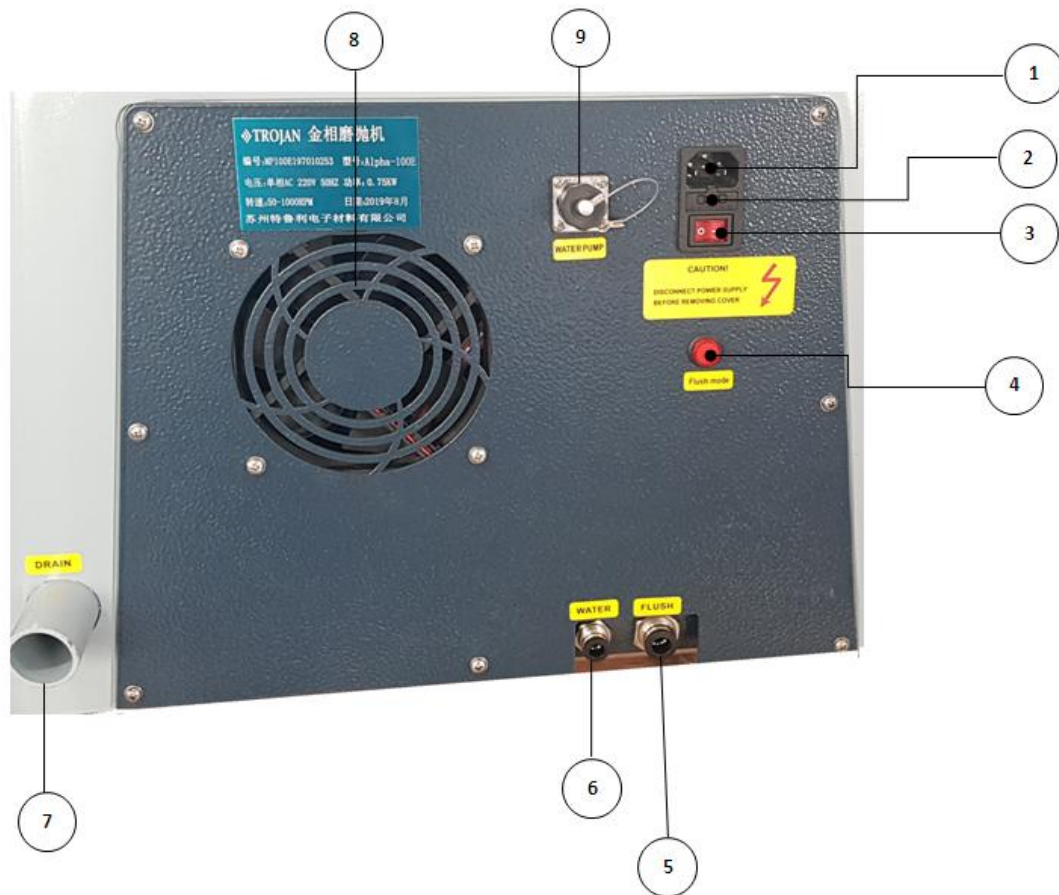







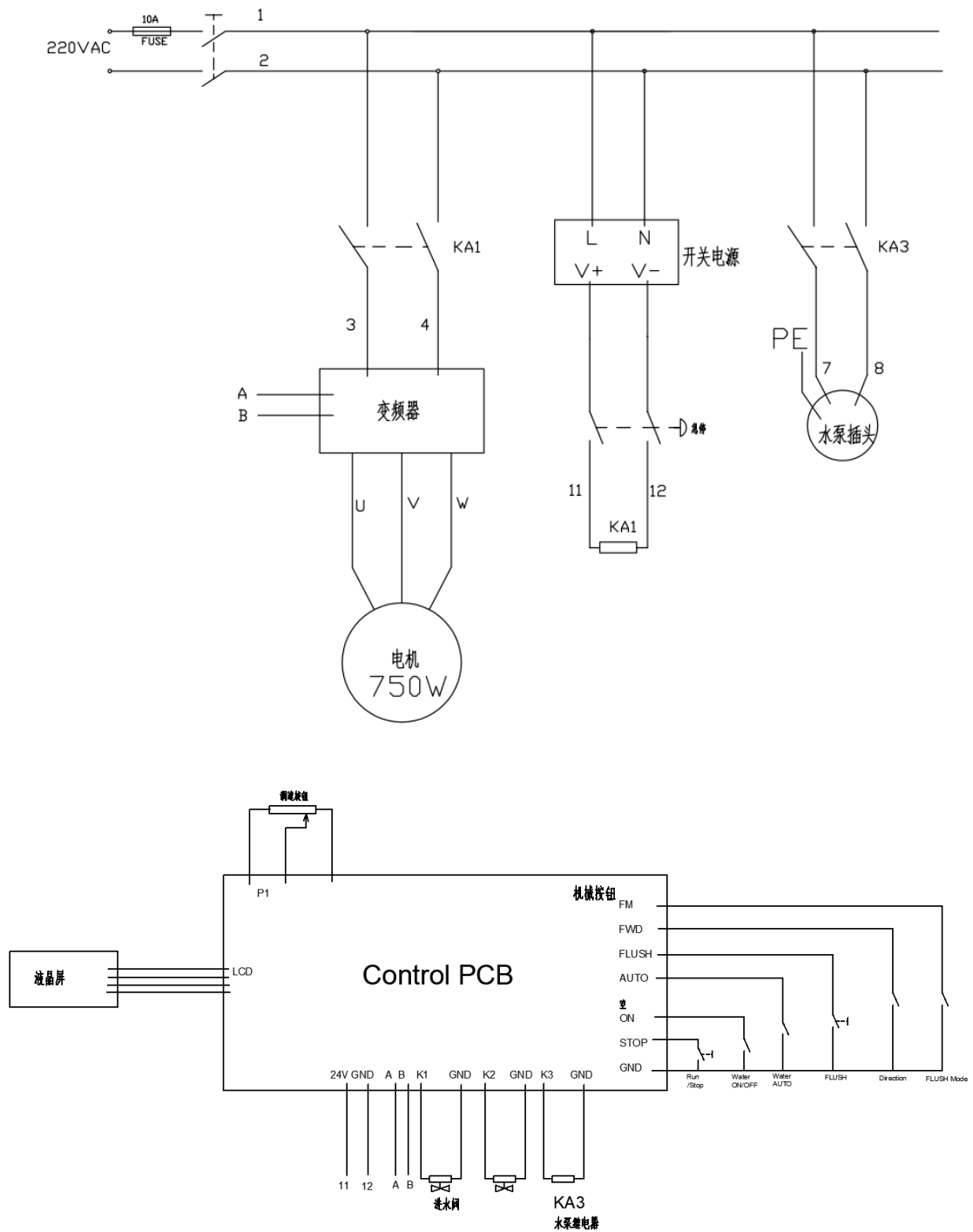



- ① Power socket;
- ② Fuse box; 10A;
- ③ Power I/O switch; Lights up, power on;
- ④ Selection of the working mode of flushing sprinkler in working disc. Press down the button and the working disc will be flushed automatically after running. When the button pops up, it will not automatically flush;
- ⑤ Cooling water (faucet) intake fast connection-peg. PE Pipe with 8 Outer Diameter;
- ⑥ In-working disc flushing water inlet joint. PE Pipe with 10 Outer Diameter;
- ⑦ Water outlet pipe joint. Bellow with 32mm Internal Diameter;
- ⑧ Cooling fan. When the temperature of the motor exceeds 50°C, the fan opens automatically and the fan stops automatically until the temperature is below 40°C;
- ⑨ Pump connector. Need to configure with a water tank. The voltage is 220V.



Building 26, No. 228, Gongtang Road, Luzhi, Wuzhong, Suzhou, China.
Tel: +86 512-65283666 www.trojanchina.com

6. Circuit Diagram



7. Equipment packing list

	Specification parameters	Quantity
	Single wheel grinder-polisher 8/10 inch working wheel,50-1000RPM,750W	1
	AlphaRING-10 10 inch paper ring. Material: ABS	1
	GUARD10 10 inch water splash guard	1
	WHEEL10 10 inch working wheel	1
	10 inch working wheel	1
	10 inch working wheel	1
	Hose for drain	1
	Instruction	1
	Certificate	1
	Abrasive Paper 180#, 200mm	10
	Abrasive Paper 400#, 200mm	10

	Abrasive Paper 800#, 200mm	10
	Abrasive Paper 1200#, 200mm	10
	Abrasive Paper 2500#, 200mm	10
	Transfer Plate AD-PB, 200mm	1
	Polishing Cloth ET-JP, 200mm	1
	Polishing Cloth YS-JP, 200mm	1

Examination Clerk:

Packing Operator: